

High Voltage Multi-Layer Chip Capacitors

Military & Commercial Grade – 500 Vdc to 10 KVdc

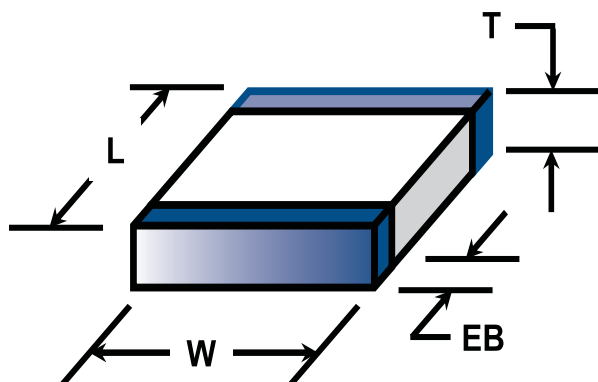

CalRamic Technologies LLC manufactures a series of highly reliable, military / commercial grade high voltage, multilayer ceramic chip capacitors that are conservatively designed and intended specifically for use in demanding high voltage, high current environments.

Intended for continuous operation at full rated voltage and across the entire operating temperature range, these capacitors utilize a special internal design specifically intended to reduce electric field stresses, thereby providing a device that exhibits very low ESR characteristics and no reduction in insulation resistance with life.

Available with ultra stable Class I, NPO and stable Class II, X7R dielectric materials, these capacitors are ideally suited for timing / precision circuitry, energy storage, DC blocking, snubbers, transient suppression, decoupling, resonators and EMI filtering applications.

A

Performance Characteristics

Specification	Dielectric Type (EIA Designation)	
	NPO (COG)	X7R
Material Classification	Type I, Ultra Stable, K90	Type II, Stable, K2500
Coefficient of Thermal Expansion	$9 \times 10^{-6} / ^\circ\text{C}$	$11 \times 10^{-6} / ^\circ\text{C}$
Density	67 g / in ³	
Operating Temperature Range	-55 to +125°C	
Aging Rate	0	-2% Max per decade hour
Temperature Coefficient	±30 PPM / °C	±15%
Voltage Coefficient	Negligible	Range -35% to -55% Max @ WVDC
Capacitance Range	10 pF to 0.33 µF	150 pF to 5.6 µF
Voltage Range	500 Vdc to 10KVdc	
Insulation Resistance @ +25°C	100,000 MΩ or 1000 MΩ - µF, W/E is less	
Insulation Resistance @ +125°C	10,000 MΩ or 100 MΩ - µF, W/E is less	
Dissipation Factor	0.1% Max	2.5% Max
DWV	1.5 x WVDC @ WVDC = 500 Vdc / 1.2 x WVDC @ WVDC > 500 Vdc	

Mechanical Dimensions

Dimensions in [mm]	Product Style																
	HV1515	HV1812	HV1825	HV2020	HV2225	HV2520	HV3333	HV3530	HV4040	HV4540	HV5440	HV5550	HV6560	HV7030	HV9040	HV11050	HV13060
Length [L] Tol ±	0.150 [3.81] 0.015 [0.38]	0.180 [4.57] 0.020 [0.51]	0.180 [4.57] 0.020 [0.51]	0.200 [5.08] 0.020 [0.51]	0.220 [5.59] 0.020 [0.51]	0.250 [6.35] 0.020 [0.51]	0.330 [8.38] 0.030 [0.76]	0.350 [8.89] 0.030 [0.76]	0.400 [10.2] 0.030 [0.76]	0.450 [11.43] 0.030 [0.76]	0.540 [13.7] 0.030 [0.76]	0.550 [14.0] 0.030 [0.76]	0.650 [16.5] 0.030 [0.76]	0.700 [17.8] 0.030 [0.76]	0.900 [22.9] 0.030 [0.76]	1.100 [27.9] 0.030 [0.76]	1.300 [33.0] 0.030 [0.76]
Width [W] Tol ±	0.150 [3.81] 0.015 [0.38]	0.120 [4.57] 0.015 [0.38]	0.250 [6.35] 0.020 [0.51]	0.200 [5.08] 0.020 [0.51]	0.250 [6.35] 0.020 [0.51]	0.200 [5.08] 0.020 [0.51]	0.330 [8.38] 0.030 [0.76]	0.300 [7.62] 0.030 [0.76]	0.400 [10.2] 0.030 [0.76]	0.400 [10.2] 0.030 [0.76]	0.400 [10.2] 0.030 [0.76]	0.500 [12.7] 0.030 [0.76]	0.600 [15.2] 0.030 [0.76]	0.300 [7.62] 0.030 [0.76]	0.400 [10.2] 0.030 [0.76]	0.500 [12.7] 0.030 [0.76]	0.600 [15.2] 0.030 [0.76]
Thickness [T] Max	0.140 [3.55]	0.100 [2.54]	0.160 [4.07]	0.180 [4.57]	0.200 [5.08]	0.180 [4.57]	0.220 [5.59]	0.220 [5.59]	0.220 [5.59]	0.220 [5.59]	0.220 [5.59]	0.220 [5.59]	0.220 [5.59]	0.220 [5.59]	0.220 [5.59]	0.220 [5.59]	0.220 [5.59]
EB Min - Max	0.010 - 0.030 [0.254 - 0.762]	0.010 - 0.040 [0.254 - 1.02]	0.010 - 0.040 [0.254 - 1.02]	0.010 - 0.040 [0.254 - 1.02]	0.010 - 0.040 [0.254 - 1.02]	0.020 - 0.060 [0.51 - 1.52]	0.020 - 0.060 [0.51 - 1.52]	0.020 - 0.060 [0.51 - 1.52]	0.020 - 0.060 [0.51 - 1.52]	0.020 - 0.060 [0.51 - 1.52]	0.020 - 0.060 [0.51 - 1.52]	0.020 - 0.060 [0.51 - 1.52]	0.020 - 0.060 [0.51 - 1.52]	0.020 - 0.060 [0.51 - 1.52]	0.020 - 0.060 [0.51 - 1.52]	0.020 - 0.060 [0.51 - 1.52]	0.020 - 0.060 [0.51 - 1.52]

High Voltage Multi-Layer Chip Capacitors

Military & Commercial Grade – 500 Vdc to 10 kVdc

Electrical Characteristics

NPO Capacitance Range																		
HV Style	1515	1812	1825	2020	2225	2520	3333	3530	4040	4540	5440	5550	6560	7030	9040	11050	13060	
Min Cap	120	120	220	220	270	270	270	270	180	180	270	270	470	120	180	330	560	
WVDC	500	472	272	822	822	123	103	153	223	393	563	823	823	104	823	104	224	334
	1000	152	122	392	392	822	682	123	183	223	333	333	473	683	393	563	104	154
	2000	271	271	821	821	102	102	222	222	392	472	562	682	103	562	103	223	253
	3000	151	121	561	561	681	681	122	152	222	392	472	562	822	472	562	153	183
	4000	•	•	•	•	•	•	681	681	122	152	222	272	392	152	332	562	822
	5000	•	•	•	•	•	•	•	•	•	122	•	222	272	122	182	392	562
	7000	•	•	•	•	•	•	•	•	•	•	•	•	•	471	102	182	272
	10000	•	•	•	•	•	•	•	•	•	•	•	•	•	•	821	122	222

X7R Capacitance Range																		
HV Style	1515	1812	1825	2020	2225	2520	3333	3530	4040	4540	5440	5550	6560	7030	9040	11050	13060	
Min Cap	271	271	561	561	681	681	471	271	471	471	681	681	821	221	471	821	122	
WVDC	500	823	563	184	184	224	224	474	564	824	125	155	185	255	155	225	395	565
	1000	223	183	473	683	823	823	254	274	394	474	684	684	105	684	105	155	225
	2000	392	252	822	123	153	183	333	333	473	683	563	104	184	823	154	254	334
	3000	•	•	272	392	472	562	123	153	183	333	333	393	823	273	563	823	124
	4000	•	•	•	•	•	•	•	682	•	103	103	153	273	123	273	473	683
	5000	•	•	•	•	•	•	•	•	•	682	-	103	153	822	223	273	393
	7000	•	•	•	•	•	•	•	•	•	•	•	•	•	332	682	103	273
	10000	•	•	•	•	•	•	•	•	•	•	•	•	•	•	392	562	103

Notes

- Group A screening available to MIL-PRF-49467.
- Special testing including Ultrasound (SLAM / CSAM) and Partial Discharge (Corona) is available. Reference CRT-0021, Space Level, HV MLCC catalog, or contact factory for more information.
- Custom voltages, package sizes and capacitance values available. Contact factory.
- X7R dielectrics are not intended for AC line filtering applications.
- Large ceramic capacitors are susceptible to damage when exposed to thermal and / or mechanical shock. Refer to technical bulletin AN101 for handling and installation recommendations or consider selecting radial leaded or surface mount alternatives as detailed in catalogs CRT-0010 and CRT-0017.
- High voltage products may require conformal coating to prevent possible arc over.

Part Number / Ordering Information

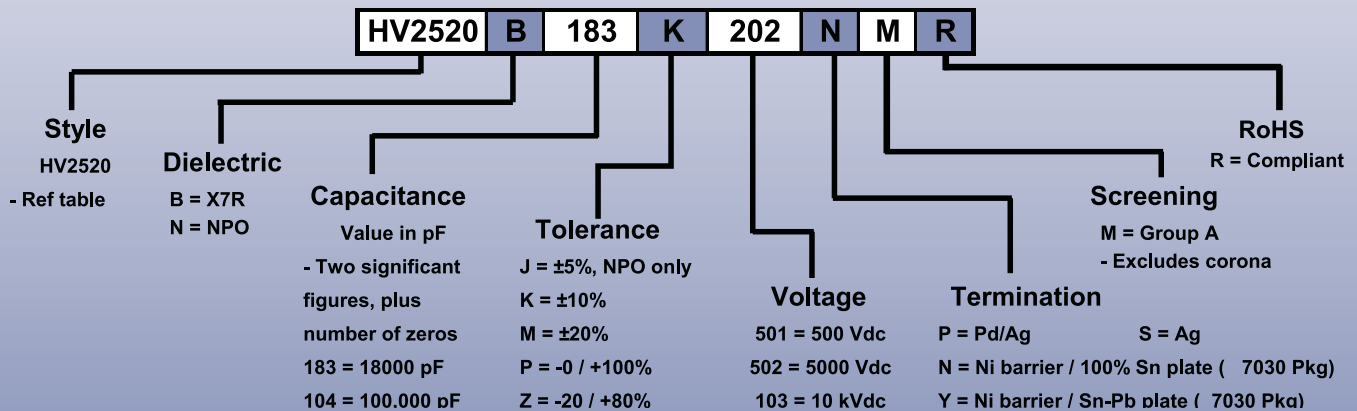

High Voltage Multi-Layer Chip Capacitors

Military & Commercial Grade – 500 Vdc to 10 KVdc

Performance Charts (Typical)

A

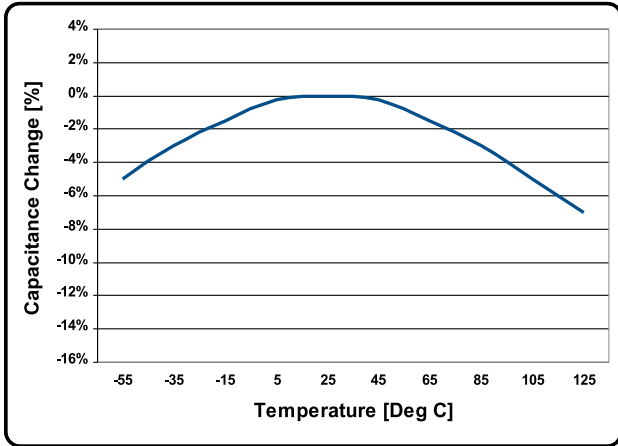

X7R Temperature Coefficient

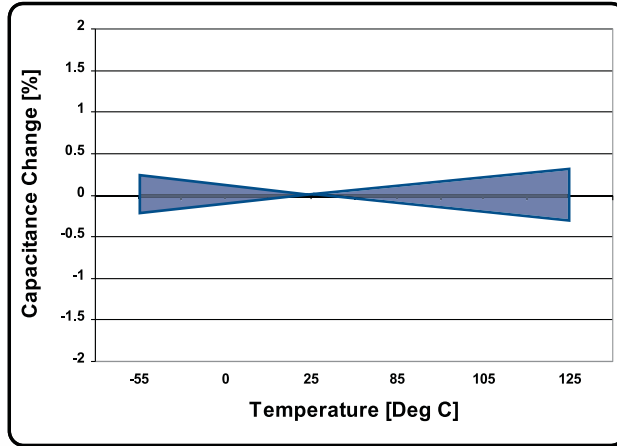

NPO Temperature Coefficient

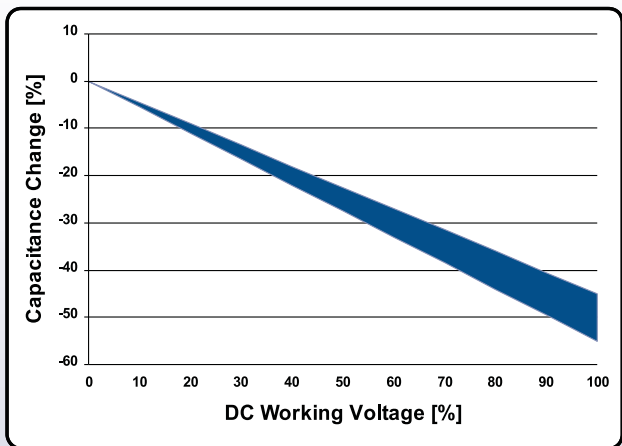

Voltage Coefficient [BR]

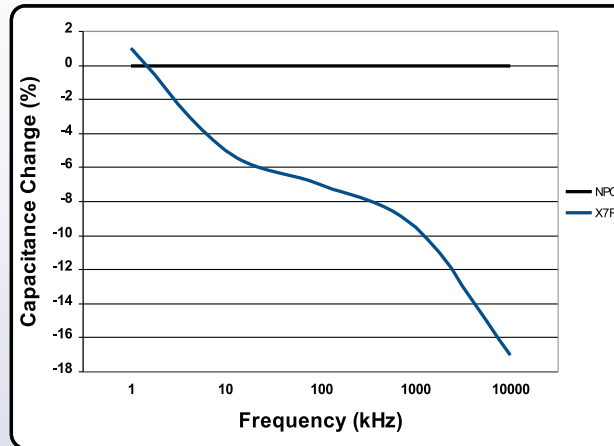

Capacitance Vs Frequency

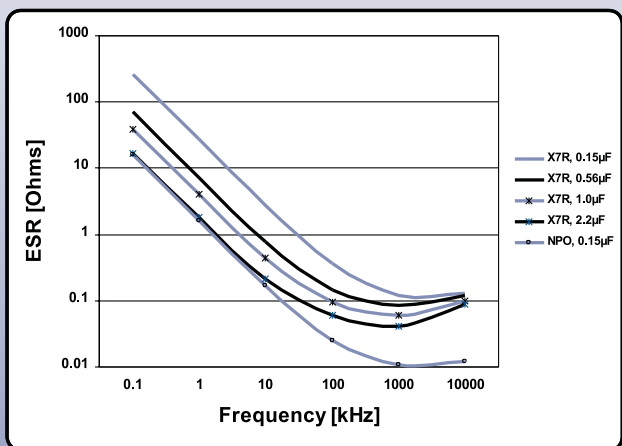

ESR Vs Frequency

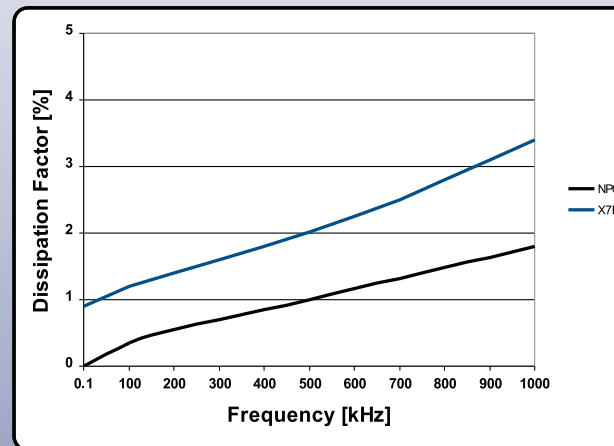

DF Vs Frequency